

S-BT-GR M8/7 SN 6
S-BT-GR NG M8/7 SN 6
S-BT-MR MT M8/7 SN 6

	SBT 4-A22
	TS-BT 5.5-74 S TS-BT 5.5-110 S
	SBT 4-A22 SFC 18/22-A
	S-DG BT M8/7 Short 6
	S-CC BT 6
	Flange nut M8-A4-70 wide

Torque tool X-BT 1/4"
8 Nm / 5.9 ft.lb

S-NS 13 C 95/3 3/4"

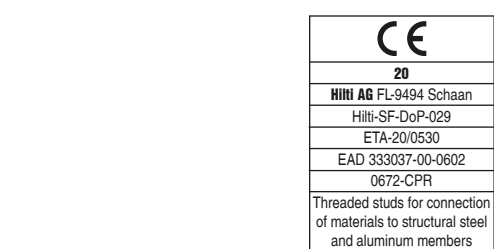
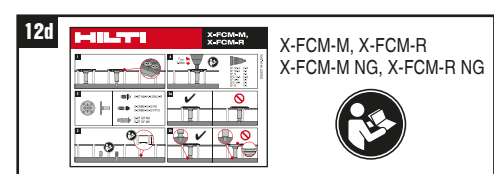
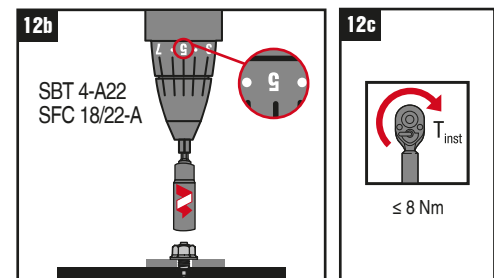
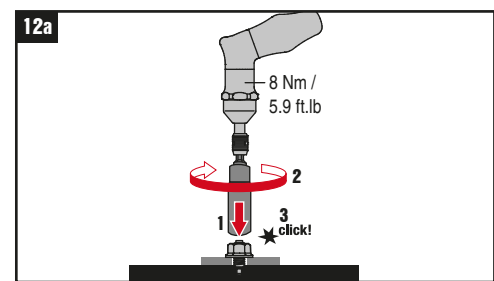
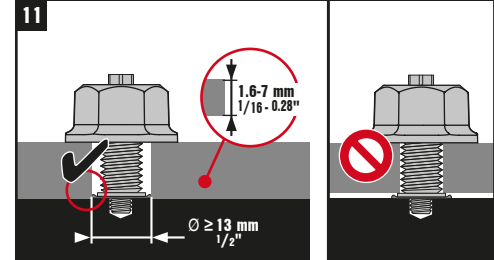
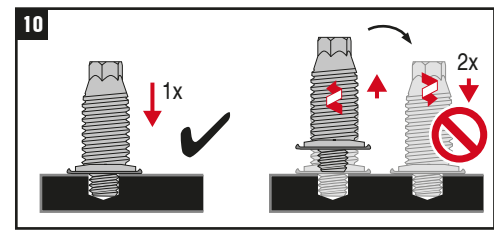
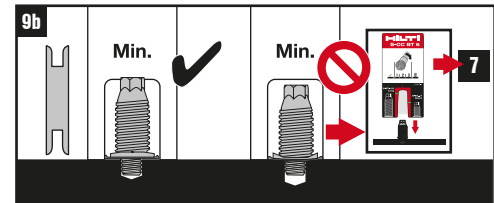
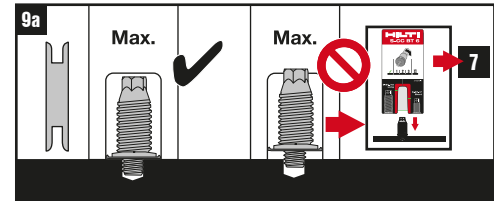
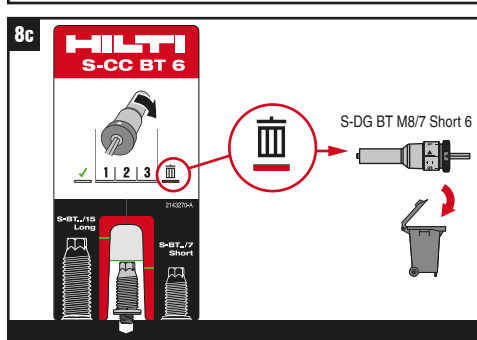
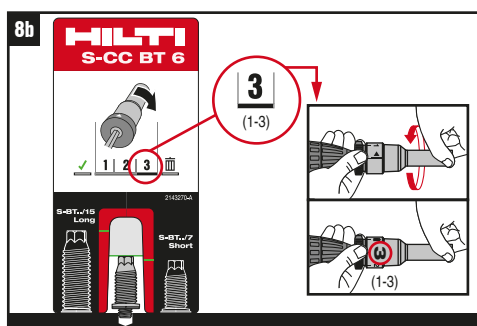
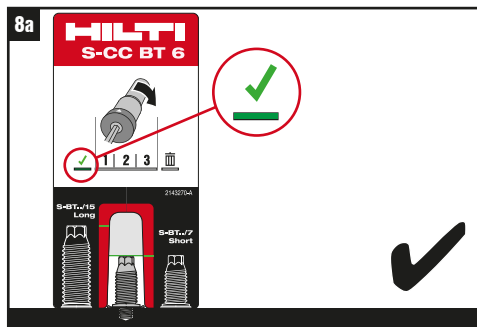
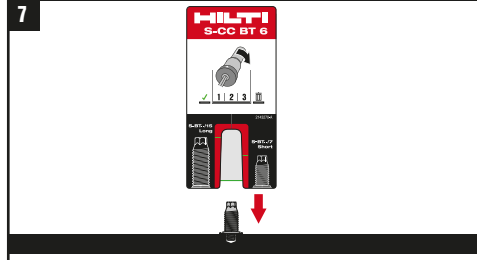
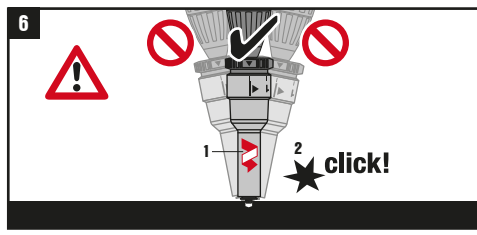
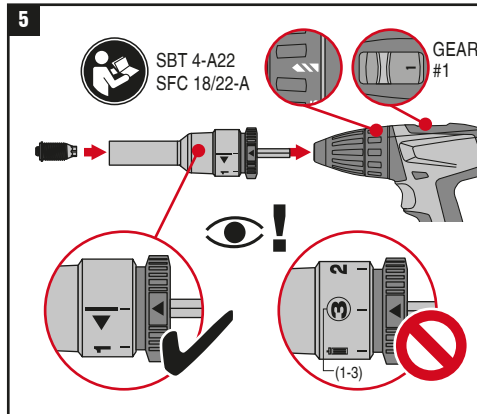
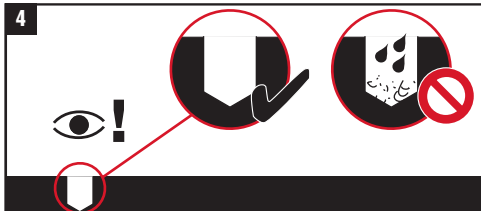
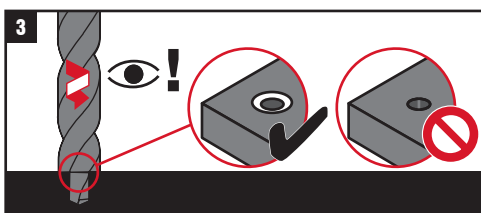
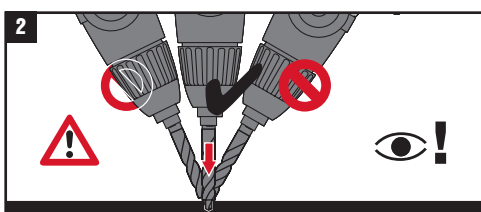
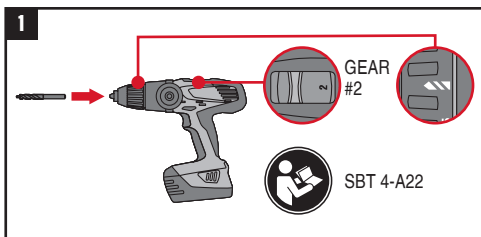

CE
20
HILTI AG FL-9494 Schaan
HilTI-SF-DoP-029
ETA-20/0530
EAD 333037-00-0602
0672-CPR
Threaded studs for connection of materials to structural steel and aluminum members